

## Modeling and simulation of Microstrip patch array for smart antennas

**K.Meena alias Jeyanthi,**  
*Assistant Professor,  
PSNA College of Engineering & Technology,  
Dindigul, Tamil Nadu, India.*

meena.jeyanthi@gmail.com

**A.P.Kabilan,**  
*Principal,  
Chetnad College of Engineering & Technology,  
Karur, Tamil Nadu, India.*

apkabilan@yahoo.co.in

---

### Abstract

The aim of the paper is two fold. One is to design and simulate an antenna array suitable for wireless applications and the other is the design of beamforming algorithm. In this paper, the first module presents the design of multiple microstrip rectangular patch elements suitable for beamforming technique in wireless applications in the range of 1.8 - 2.4 GHz. By designing 1x8 patch array, it is possible to achieve 15 dB gain and 58% more directivity compared to the conventional patches. The second module suggests a NLVFF-RLS algorithm for beamforming technique to concentrate the power in the desired direction and nullify the power in the interferer direction with HPBW of 13°. The results are analyzed for the scanning sector of -60° to 60°. The modeling and simulation of antenna array is computed using Agilent's ADS. The beamforming algorithm is designed in Matlab.

**Key words:** Adaptive antennas, antenna arrays, microstrip patch, beamforming.

---

### 1. INTRODUCTION

The rising importance of wireless communication and multimedia services increasing the efforts to the design and implementation of novel microstrip patch structures from miniaturized electronic circuits to the antenna arrays[2]. The main advantages of microstrip patches are light weight, low cost, planar or conformal and ability of integration with electronic or signal processing circuitry. Microstrip antenna elements radiates efficiently as devices on microstrip printed circuit boards. Microstrip antenna array consists of microstrip antenna elements, feed and phasing networks. Designing microstrip structure requires understanding of both mathematical relatives and applications[2]. The microstrip array is very reliable since the entire array is one continuous piece of copper.

Microstrip patch antenna consists of a radiating patch on one side of a dielectric substrate with a continuous metal layer bonded to the opposite side of the substrate which forms a ground plane. The patch is generally made of conducting material such as copper or gold and can take any possible shape. A patch antenna is a narrowband, wide-beam antenna fabricated by photo etching the antenna element pattern in metal trace on the dielectric substrate shown in figure 1.

#### 1.1 Design of microstrip patch array

The following are the design equations of the single patch[2],  
 The actual Length of the Patch is,

$$L = \frac{\lambda}{2\sqrt{\epsilon_r}} \tag{1}$$

Effective relative dielectric permittivity,

$$\epsilon_{r_{eff}} = \frac{\epsilon_r + 1}{2} + \frac{\epsilon_r - 1}{2} \left[ 1 + 12 \frac{h}{W} \right]^{-\frac{1}{2}} \tag{2}$$

the effective Length of the Patch is,

$$L_{eff} = \frac{c}{2f_o \sqrt{\epsilon_{r_{eff}}}} \tag{3}$$

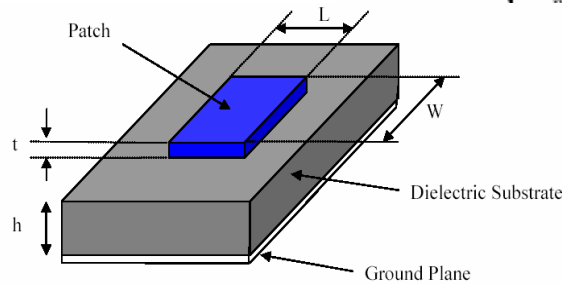
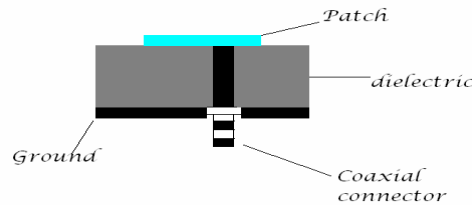

**FIGURE 1:** Rectangular microstrip antenna element

The Extension Length due to fringing field,

$$\Delta L = 0.412h \frac{(\epsilon_{r_{eff}} + 0.3) \left( \frac{W}{h} + 0.264 \right)}{(\epsilon_{r_{eff}} - 0.258) \left( \frac{W}{h} + 0.8 \right)} \tag{4}$$

The coaxial feed is a very common technique used for feeding microstrip patch antennas as shown in figure 2.



**FIGURE 2:** side view of element with coaxial feed

**1.2 Simulation of single and multiple array**

A single patch antenna provides a maximum directive gain of around 6-9 dB. It is relatively easy to print an array of patches on a single (large) substrate using lithographic techniques[2]. Patch arrays can provide much higher gain than a single patch at little additional cost; matching and phase adjustment can be performed with printed microstrip feed structures. The ability to create high gain arrays in a low-profile antenna is one reason that patch arrays are common in all wireless applications[2]. The antenna model is simulated by Agilent’s ADS which is a powerful tool in the design of multilayer microstrip antennas. In early days, most of the designers uses graphical tool for the design of antennas[10,11]. Figure 3 shows the return loss of -13 dB for single patch and figure 4 shows the return loss of -18dB for 1x8 patch array for the center

frequency of 1.85GHz. Even the fractal antennas have the  $S_{11}$  of -27dB which is comparable with this.[9].Figure 3 & 4 shows the return loss is obtained for the same resonant frequency of 1.85GHz accurately.

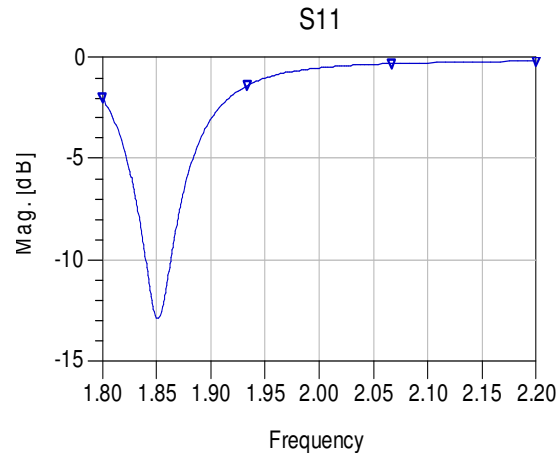

FIGURE 3: Return loss of single patch

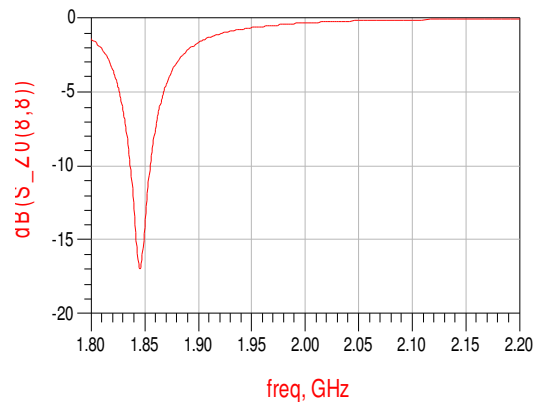

FIGURE 4: return loss of 1x8 elements

## 2. DESIGN OF ARRAY OF PATCHES

### 2.1 Substrate selection

It is important to choose a suitable dielectric substrate of appropriate thickness 'h' and loss tangent 'δ'. A thicker substrate are mechanically strong, will increase the radiated power, reduce conductor loss and improve the impedance bandwidth[2]. A high loss tangent increases the dielectric loss and therefore reduces antenna efficiency. Here the substrate selected as 1/32in(1.58mm)and loss tangent of 0.024 for the operating frequency ranges from 1.8-2.4GHz.

### 2.2 Element width and Length

Patch width has a minor effect on the resonant frequency and radiation pattern of the antenna. With the proper excitation, a patch width 'W' greater than the patch length 'L' without exciting undesired modes. The patch width affects the cross polarization characteristics.

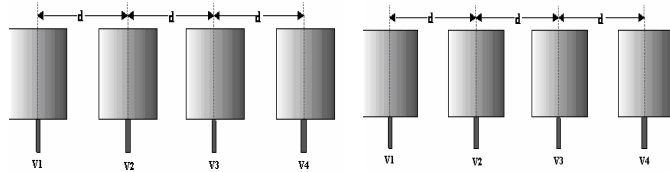

**FIGURE 5:** Array of 8 patches

In this paper, a broadband rectangular microstrip patch antenna using the permittivity of  $\epsilon_r$  of 4.28,  $\log \tan \delta$  of 0.024. The length and breadth of the patch is 51.25mm and 40.01mm respectively. The uniform linear array of patches with spacing of  $0.5\lambda$  are arranged as shown in figure 5.

### 2.3 Radiation pattern

The radiation pattern of an antenna is prime important in determining most of the characteristics which include beamwidth, beam shape, sidelobe level, directivity and radiated power. Radiation pattern is computed using method of moments in ADS.

### 2.4 Beamwidth

The half power beamwidth(HPBW) of an antenna is equal to the angular width between the directions where radiated fields reduced to  $1/\sqrt{2}$  times the maximum value.

### 2.5 Directivity and gain

The directivity is a measure of the directional properties of an antenna compared to the isotropic antenna. Directivity is generally high for array antennas. The gain of the antenna directly depends on the radiation efficiency and the directivity of the antenna[2]. It is observed that directivity increases with increase of substrate thickness and patch width. Conversely, the beamwidth is expected to decrease for higher values of 'h' and 'W'.

Figure 6 shows the E plane beamwidth of the array. The dimensions and the antenna parameters are tabulated in table 1.

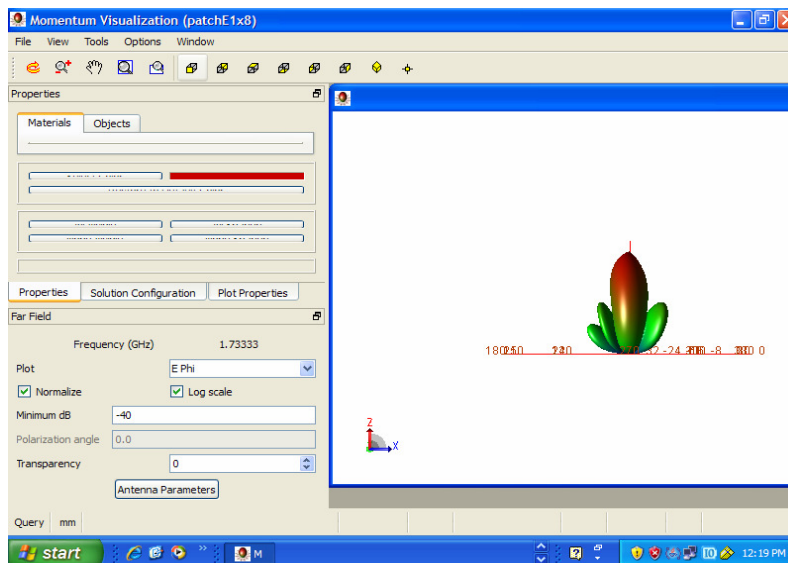

**FIGURE 6:** Radiation pattern of 1x8 patches

The conventional single patch has the directivity of 7-8dB. But it is observed that the directivity of 1x8 array is improved by 6 dB compared to the single patch. The gain of the array is found to be 15 dB.

Operating frequency( $f_0$ )	1.85 GHz	Power radiated(Watts)	0.046
Width of single patch(W)	51.25mm	Effective angle(deg)	0.41 steradian
Length of single patch(L)	40.01mm	Directivity(dB)	14.832
Height	1.5 mm	Gain(dB)	14.8287
No.of elements	8	Intensity(Watts)	0.112
Distance between elements	$0.5 \lambda$	E(theta)	81.68
Feed line length	9.5 mm	E(phi)	82.68
Radius of the field	0.5 mm		

**Table 1:** Antenna parameters

### 3. SMART ANTENNAS

Smart antennas gain more space in modern wireless communication systems using the important property of spatial filtering[8]. The increasing demand for mobile communication services in a limited RF spectrum motivates the need for better techniques to improve spectrum utilization as well as the development of new high bit rate applications[1]. A smart antenna is an antenna array system aided by some smart algorithm designed to adapt to different signal environments[2]. In this paper our approach is presented by designing an adaptive algorithm using a linear arrangement of rectangular antenna array, with 8 elements, a high degree-of-freedom exists to synthesize very sophisticated radiation patterns[7].

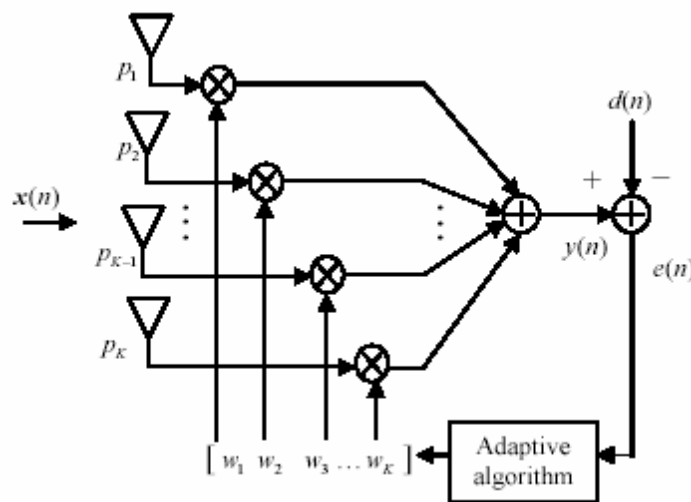

**FIGURE 7:** Structure of the adaptive array

A linearly arranged and equally spaced array of antenna forms the structure of a beam former. In order to form a beam, each user input signal is multiplied by a set of complex weights and then transmitted from the array to the distant point, the signal emitted from the antennas in the array differ in phase as well as amplitude. If the weights are computed and updated in real time, the process is known as adaptive beam forming [3]. The structure of the adaptive antenna array is shown in figure 7.

Adaptive process permits narrower beam and improving the signal to noise ratio only in the direction of that particular user. This technique drastically reduces the interference in the system. In digital beamforming, the received RF signals are down converted to intermediate frequency (IF) and then digitized by Analog-to-digital converters (ADC). The availability of digital signals enables the use of a considerable number of processing algorithms, because the adaptation can be performed by the controlling software at a lower frequency.

### 3.1. Non linear variable forgetting factor recursive least squares algorithm (NLVFF-RLS)

The Recursive Least Squares (RLS) algorithm offers an alternative to the LMS algorithm as a tool for the solution of adaptive filtering problems. This algorithm uses the least squares estimate of the tap weight vector of the filter at iteration  $n-1$ , to compute the updated estimate of the vector at iteration 'n' upon the arrival of new data. Hence this algorithm is referred as the Recursive Least Squares (RLS) algorithm.

The recursive equation for updating the tap- weight vector is,

$$\bar{W}(n) = \bar{W}(n-1) + k(n)\bar{\xi}^*(n) \tag{5}$$

$$\bar{\xi}(n) = d(n) - u^T(n)\bar{W}^*(n-1), \tag{6}$$

is the a priori estimation error.

$k(n)$  is the gain vector.  $k(n)$  is expressed as

$$k(n) = \frac{\pi(n)}{\lambda + u^H(n)\pi(n)} \tag{7}$$

The intermediate quantity  $\pi(n)$  is computed as

$$\pi(n) = P(n-1)u(n) \tag{8}$$

The inverse correlation matrix is computed as

$$P(n) = \lambda^{-1}P(n-1) - \lambda^{-1}k(n)u^H(n)P(n-1) \tag{9}$$

### 3.2 Forgetting factor

In the case of non stationary environment, the algorithm[3] uses the forgetting factor  $\lambda \in (0,1)$ . Here the constant forgetting factor used is  $\lambda = 0.95$ . The constant forgetting factor will not produce the optimal performance. Hence the nonlinear variable forgetting factor is preferred. RLS approach leads to higher complexity, but provides a higher speed of convergence and performs better in flat fading channels. The nonlinear forgetting factor can be obtained by error measurements and updating the constant forgetting factor  $\lambda$  non linearly. The optimal filtering gain  $k$  should be chosen in such a way that the equalization error is an uncorrelated noise sequence.

$$\lambda_i = \frac{\lambda_{i-1}(1 + u^H(n)P(i-1)u(i-1))}{S_i} \tag{10}$$

where  $\lambda^{-1}P(n-1)u_i - k_i S_i = 0$ ,

This algorithm produces feed back control by updating the gain and forgetting factor  $\lambda$  based on the nonstationary environment.

### 4. RESULTS AND DISCUSSION

The simulated system consists of an eight element uniform linear array spaced at half wavelength. The operating frequency selected as 1.8GHz. The channel is modeled as additive white Gaussian channel. The received signals are modeled in the base band processing and modulated by MSK (Minimum Shift Keying) signals. The modulated signals are multiplied by steering vectors to simulate array processing technology. Inverse correlation matrix was computed, and the weights are updated.

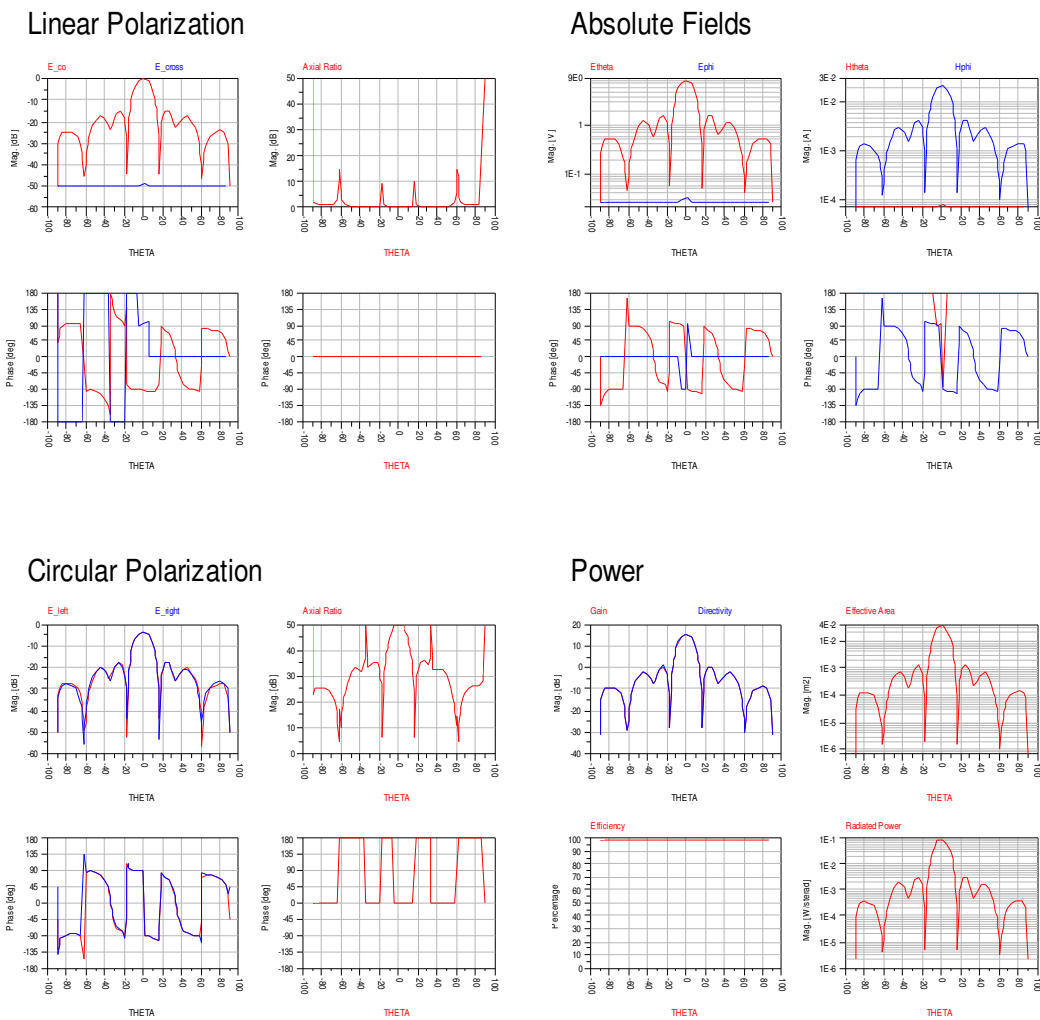
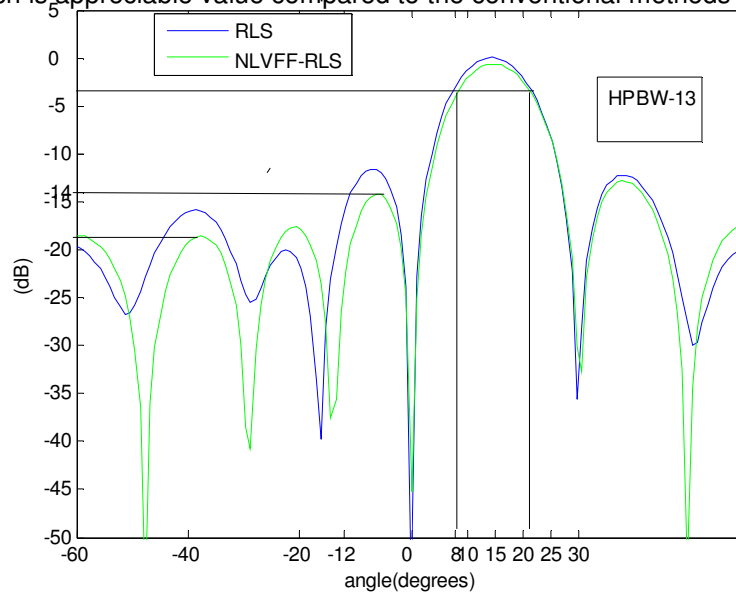

FIGURE 8: Amplitude response of the array

Figure 8 shows the Amplitude response the 1x8 antenna array. Figure 9 shows the power pattern comparison of NLVFF-RLS and RLS algorithm which is scanning efficiently with half power beam width of 13° for the scanning sector of -60° to 60°. The side lobe level is varying between -14 dB to -18dB which is appreciable value compared to the conventional methods [12].



**Figure 9:** Beam pattern comparison of NLVFF-RLS and RLS

The various parameters are computed for the scanning sector of -60° to 60° are half power beam width(HPBW), null point suppression and compared with the conventional LMS and RLS algorithms are shown in table 2.

Algorithm	HPBW (deg)	SLL (db)	No.of Iter	Null point Supp (db)
LMS	14	12	25	30
RLS	18	14	15	40
NLVFF-RLS	13	14	10	50

**Table 2:** Comparison of algorithms

#### 4. CONCLUSION

Due to the high cost and complexity of the design for planar and high resolution array, the design focused on the development of uniform linear array antenna. The array designed using method of moments in ADS to obtain the directivity of 14 dB (58% increase compared to the normal patch).The proposed structure uses the spacing 0.5 λ, provides the return loss of 18 dB referenced to the center frequency 1.85 GHz. The second goal is achieved by concentrating the power in the specified direction with a HPBW of 13° in the scan sector of -60° to 60°. Simulation results showed that NLVFF-RLS provides remarkable improvement in null point suppression of 50dB, convergence rate of 10 iterations and minimum mean square error over that of RLS. The



presented algorithm confirms the adaptive antennas are able to sustain a large number of simultaneous communication with respect to directional and switched beam technologies.

## 5. REFERENCES

1. Simon Haykin, "Adaptive Filter Theory", Fourth edition n, 2002
2. Ramesh Gharg, Prakash Bhartia, "Microstrip Antenna design Handbook", Artech House, 2000
3. Jeffrey H. Reed, "Software Defined radio", Pearson education, 2006
4. M.Mukhopadhyay, B.K.Sarkar, "Augmentation of antijam GPS system using smart antenna with a simple DoA estimation algorithm", PIER, 67, 231-249,2007.
5. L. J. Griffith and C. W. Jim, "An Alternative Approach to Linearly Constrained Adaptive Beamforming", *IEEE Trans. AP*, 30(1): 27–34, 1982.
6. K.Meena alias Jeyanthi, Dr.A.P.Kabilan, "A simple adaptive beamforming algorithm with interference suppression", International journal of Engineering and Technology, vol.1, NO.1, pp 67-70, April 2009.
7. K.Meena alias Jeyanthi, Dr.A.P.Kabilan, "A NLVFF-RLS approach to adaptive beamforming for wireless communication", ICCNET,2008.
8. A.P. Kabilan, P. Elizabeth Caroline, X. Susan Christina, "An optical beamformer for smart antennas in mobile broadband communication", International journal of mobile communications, vol.7, no.6, pp-683-694, 2009.
9. Niruth Prombutr, Prayoot Akkaraektharm, "Analysis and design of Hilbert curve fractal antenna feed with coplanar wave guide for multiband wireless communications", International Journal of Engineering, volume 2, Issue 3, 2003.
10. Z.Rostamy, "Determination of resonant requency of dominant and higher order modes in thin and thick circular mcrostrip patch antennas with superstrate by MWM", International journal of Engineering,volume 16, November 2003.
11. M.R. Doushabchizadeh, S. Taromi and A.Radji, "TV and OR FM transmitting antennas design using computer graphic system", volume 7, International Journal of Engineering, August 1994.
12. Ali Varahram, Jalil Rashed Mohassel, K.Mafinezhad, "Optimization of array using modified genetic algorithm", Vol. 17, No 4, IJE Transactions: Applications, Dec 2004.